

Symbol:

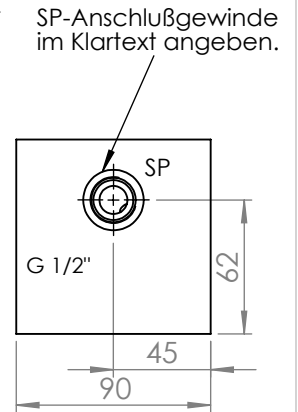

SP-Anschlußgewinde im Klartext angeben.

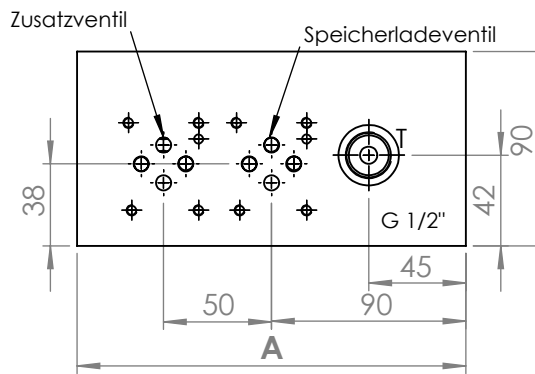
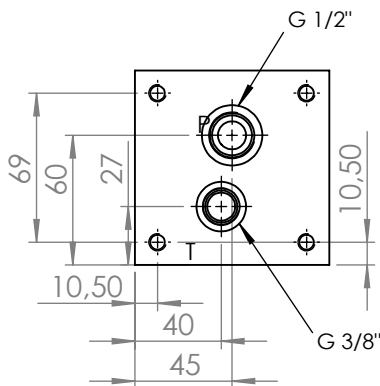
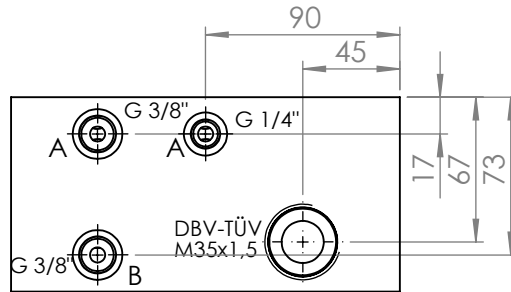
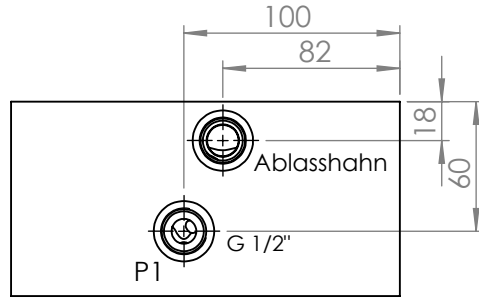
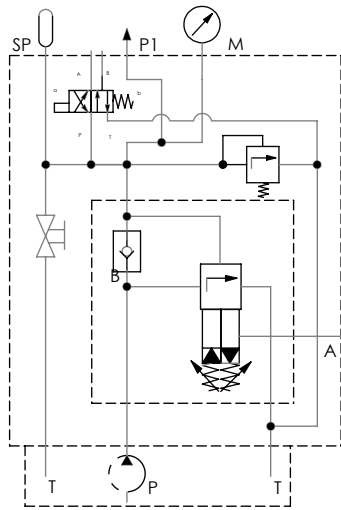
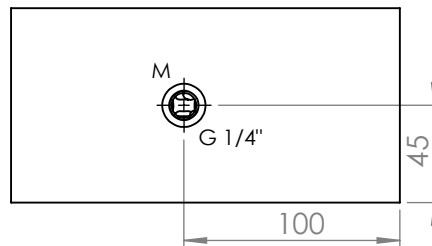

Ablasshahn im Lieferumfang enthalten.

Änderungen vorbehalten

Anzahl der Zusatzventile	A	Bestellnummer
1	180	906011
2	230	906012
3	280	906013
4	330	901614
5	380	901615
6	430	906016
7	480	901617
8	530	901618

<p>H & S Hydraulik & Steuerblöcke</p> <p>Hartmannstr. 55 72458 Albstadt Tel.: 07431/701794 Fax.: 07431/701793</p>	<p>Statischer Betriebsdruck:</p> <p>max. 315 bar</p>		<p>NAME: R. Grotz</p> <p>DATE: 05.12.07</p>	<p>H & S</p> <p>Speicherladeblock NG 6 CETOP 03</p>	
	<p>MATERIAL: AlCuMg1 F38</p>		<p>CHECKED</p> <p>ENG APPR.</p> <p>MFG APPR.</p> <p>Q.A.</p> <p>COMMENTS:</p>		
	<p>NEXT ASSY</p> <p>USED ON</p>	<p>FINISH</p>	<p>SCALE: 1:2</p> <p>WEIGHT:</p>		<p>SIZE: A</p> <p>DWG. NO.: 906011</p> <p>REV. A</p>
	<p>APPLICATION</p> <p>DO NOT SCALE DRAWING</p>		<p>SHEET 1 OF 1</p>		