

Umlenkzwischenplatten NG 06

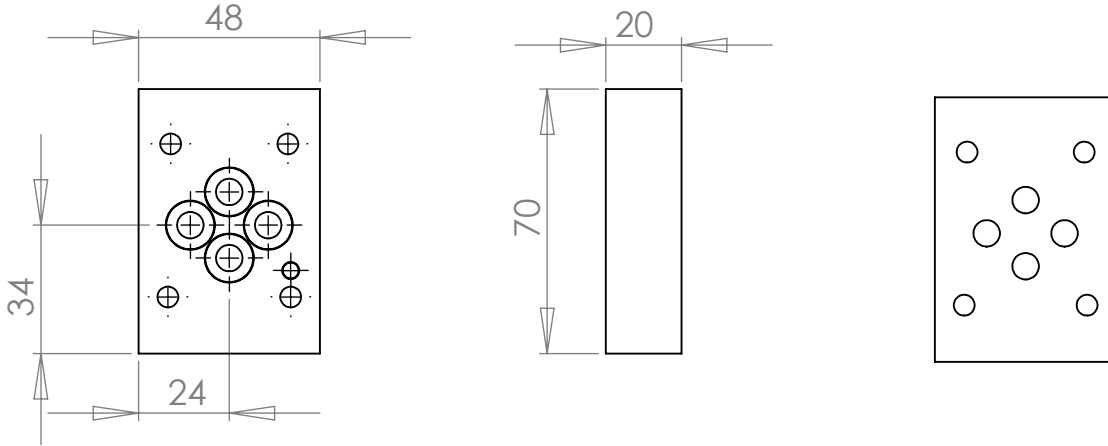

Symbol

Bezeichnung

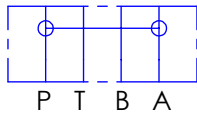

Umlenkzwischenplatte NG 06 P-A

8060280

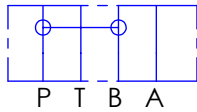

Umlenkzwischenplatte NG 06 P-B

8060281

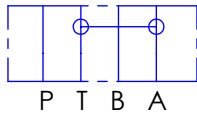

Umlenkzwischenplatte NG 06 T-A

8060282

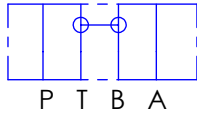

Umlenkzwischenplatte NG 06 T-B

8060283

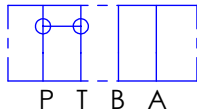

Umlenkzwischenplatte NG 06 P-T

8060284

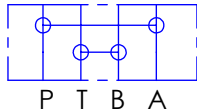

Umlenkzwischenplatte NG 06 P-A / T-B

8060285

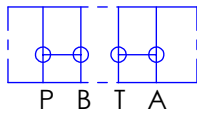

Umlenkzwischenplatte NG 06 P-B / T-A

8060286

Sonderausführung auf Anfrage

Änderungen vorbehalten

MAX. 315 bar

	NAME	DATE
DRAWN	R. Grotz	05.12.07
CHECKED		
ENG APPR.		
MFG APPR.		
Q.A.		
COMMENTS:		

H & S

Umlenkzwischenplatten
NG 06

H & S
Hydraulik & Steuerblöcke
Hartmannstr. 55
72458 Albstadt
Tel.: 07431/701794
Fax.: 07431/701793

		MATERIAL	AICuMg1 F38
NEXT ASSY	USED ON	FINISH	
APPLICATION		DO NOT SCALE DRAWING	

70x20x48

SIZE **A** DWG. NO. 8060280

REV. **A**

SCALE:1:2 WEIGHT: SHEET 1 OF 1